

REV 01

DATE: February 26 2018

Avid Controls Inc.
41261 Park 290 Drive, Waller, TX 77484, USA
info@avidcontrolsinc.com
(+1) (281) 640-8600

THIS PAGE IS INTENTIONALLY BLANK

AVID Controls Inc. pursues a policy of continuous product improvement and innovation. This may not be the latest revision of this publication and may not reflect all current product changes. Contact AVID Controls Inc. for the latest revision of this data sheet and information on other product enhancements.

Contents

1.	Introduction	5
1.1	Who Should Use	5
1.2	Purpose and Scope	5
1.3	Symbol Conventions Used in this Manual and on Equipment	6
2.	Product Description	7
2.1	General Specifications	7
2.2	General Precautions and Safety Warnings	8
3.	Installation Instructions	9
3.1	Product Inspection	9
3.2	Site Selection	9
3.3	Mounting	9
3.4	Wiring and Customer Connections.....	10
3.4.1	Power Wiring	10
3.4.2	I/O Wiring	11
3.5	Typical Configurations	12
4.	Operation	14
4.1	Functional Description.....	14
4.2	Features.....	14
4.2.1	Indicators	14
4.2.2	Terminal Strip I/O	15
4.2.3	Master / Slave Control.....	16
4.3	Startup.....	17
4.3.1	Pre-Power Checks	17
4.3.2	Cut-In and Overvoltage Selections, J1 & J2	17
4.3.3	Master/Slave, J3	18
4.3.4	Startup Procedure and Checks.....	18
4.4	Operational Adjustments	18
5.	Maintenance and Troubleshooting	19
5.1	Periodic Testing	19
5.2	Maintenance Items	19
5.3	Troubleshooting.....	19
5.3.1	Green LED on PCB not illuminated.....	19
5.3.2	Fan doesn't run.....	20
5.3.3	Status contacts won't close.....	20
5.3.4	Module over-temp, or module seems too hot.....	20
5.3.5	Drive trips on overvoltage.....	20
5.3.6	Master/Slave systems	21
5.3.7	Red Active Braking led flickers	21
5.3.8	Red Braking light stays on all the time	21

- 5.3.9 Master Unit appears to function properly, but Slave Units do not seem to follow the Master 21
- 5.3.10 Attached Drive Will Not Precharge 21
- 5.4 Technical Help – before you call..... 22
- 6. Engineering Data..... 23
 - 6.1 Ratings Chart 23
 - 6.2 DC Bus Link Length Limits 24
 - 6.3 Resistor Link Length Limits..... 24
 - 6.4 Dimensions and Mechanical Drawings 25
 - 6.5 BLOCK DIAGRAMS..... 26
- 7. Document Revision History 26

AVID CONTROLS and the  logo are registered trademarks of Avid Controls Inc.

1. Introduction







1.1 Who Should Use

- This manual is intended for use by anyone who is responsible for integrating, installing, maintaining, troubleshooting, or using this equipment with any AC drive system.
- Please keep this manual for future reference.

1.2 Purpose and Scope

- This manual is a user's guide for the GDB400-4705-A dynamic braking module. It will provide the user with the necessary information to successfully install, integrate, and use the GDB400-4705-A dynamic braking module in a variable frequency AC drive system.
- In the event of any conflict between this document and any publication and/or documentation related to the AC drive system, the latter shall have precedence.

1.3 Symbol Conventions Used in this Manual and on Equipment

	Earth Ground or Protective Earth
	AC Voltage
	DC Voltage
 <p>DANGER!</p>	DANGER: Electrical hazard - Identifies a statement that indicates a shock or electrocution hazard that must be avoided.
 <p>DANGER!</p>	DANGER: Identifies information about practices or circumstances that can lead to personal injury or death, property damage, or economic loss.
 <p>CAUTION!</p>	CAUTION: Identifies information about practices or circumstances that can lead to property damage, or economic loss. Attentions help you identify a potential hazard, avoid a hazard, and recognize the consequences.
 <p>CAUTION!</p>	CAUTION: Heat or burn hazard - Identifies a statement regarding heat production or a burn hazard that should be avoided.

2. Product Description

- Avid GDB400-4705-A dynamic braking units (DB units) are used with AC drives to allow full power braking and eliminate overvoltage faults. This permits controlled braking and dramatically shortens motor stopping time.
- The GDB400-4705-A works with variable frequency drives (with DC bus connections) to monitor the DC bus. If the DC voltage reaches a pre-determined level, the GDB400-4705-A shunts the excess energy through an external braking resistor to prevent overvoltage faults.
- The need for regenerated voltage control occurs in applications where the frequency of an AC motor at times exceeds that of its variable frequency drive. In this case, the motor acts as a generator. The energy generated by the motor must be dissipated as heat or returned to the power line. If this energy is not controlled, the motor may run with high peak voltages, the energy may be dissipated as heat in the motor, or the drive may trip on an over-voltage condition.

2.1 General Specifications

PARAMETER	SPECIFICATION		
DC Bus Voltage	400 - 1263VDC		
DC Braking Current	400 Amps Peak 25% Duty (Up to 30 seconds in 120)		
System Voltage	380Vac – 690Vac \pm 20%		
Indicators on PCB	Control Power	LD1 Green	Power and Status
	Active Braking	LD3 Red	On when IGBT is on
	Sig In	LD4 Green	Signal to be active received
	Sig Out	LD5 Green	Signal to be active (Master)
Logic I/O	Inputs – dry contact	Outputs – Max 120VAC 3 Amps	
	Enable/Reset	Status	
Control I/O	Master/Slave Sharing Control Signal		
Operating Temp	0° to 50°C		
Storage Temp	-20° to 65°C		
Humidity	Below 90%, non-condensing		
Atmosphere	Free of corrosive gas or conductive dust		

2.2 General Precautions and Safety Warnings



- **HIGH VOLTAGES MAY BE PRESENT!**
- **NEVER ATTEMPT TO SERVICE THIS PRODUCT WITHOUT FIRST DISCONNECTING FROM THE INCOMING AC POWER AND DC BUS.**
- **ALWAYS ALLOW ADEQUATE TIME FOR RESIDUAL VOLTAGES TO DRAIN BEFORE ATTEMPTING SERVICE.**
- **BEFORE ATTEMPTING INSTALLATION OR REMOVAL OF THIS PRODUCT, BE SURE TO REVIEW ALL AC DRIVE DOCUMENTATION FOR PERTINENT SAFETY PRECAUTIONS.**
- **INSTALLATION AND/OR REMOVAL OF THIS PRODUCT SHOULD ONLY BE DONE BY A QUALIFIED ELECTRICIAN IN ACCORDANCE WITH NATIONAL ELECTRICAL CODE OR EQUIVALENT REGULATIONS.**
- **FAILURE TO HEED THESE WARNINGS MAY RESULT IN SERIOUS BODILY INJURY OR DEATH.**



- **THIS PRODUCT WILL GENERATE HEAT DURING OPERATION.**
- **THIS PRODUCT SHOULD BE INSTALLED ACCORDINGLY ON NON-FLAMMABLE SURFACES WITH CLEARANCES OF AT LEAST TWO INCHES IN ALL DIRECTIONS.**
- **ALWAYS ALLOW AMPLE TIME FOR THE UNIT TO COOL BEFORE ATTEMPTING SERVICE ON THIS PRODUCT.**
- **ALWAYS BE SURE THE BRAKING CAPACITY OF THE CHOPPER AND LOAD BANK DOES NOT EXCEED THE CAPACITY OF THE CONNECTED DRIVE!**

Important Notice about Drives with DC Link Chokes!

- **DURING BRAKING SITUATIONS, ENERGY STORED IN A DRIVE'S DC LINK CHOKES CAN CREATE EXTREME OVER-VOLTAGE CONDITIONS FOR DYNAMIC BRAKING CONTROL MODULES. TO AVOID THESE CONDITIONS, DC CONNECTIONS FROM RESISTIVE BRAKING CONTROL MODULES TO THE DRIVE SYSTEM MUST ALWAYS BE MADE DIRECTLY IN PARALLEL WITH THE DRIVE'S FILTER CAPACITORS. THESE MODULES SHOULD NEVER BE CONNECTED IN SERIES WITH A DRIVE'S DC LINK CHOKES.**
- **BE SURE TO REVIEW THE PERTINENT AC DRIVE DOCUMENTATION TO ENSURE THAT THE PROPER CONNECTIONS ARE USED.**
- **CONTACT THE DRIVE MANUFACTURER OR EQUIPMENT SUPPLIER FOR ASSISTANCE WITH DRIVE CONNECTIONS.**

ANY QUESTIONS RELATING TO APPLICATION, INSTALLATION, OR SERVICE SAFETY SHOULD BE DIRECTED TO THE EQUIPMENT SUPPLIER.

3. Installation Instructions



Installation and/or removal of this product should only be performed by a qualified electrician in accordance with National Electrical Code or local codes and regulations.

- Proper installation of the model GDB400-4705-A DB module should be accomplished following the steps outlined below. Be sure to refer to all other pertinent system documentation as these steps are performed. Please direct all installation inquiries that may arise during the installation and startup of this product to the equipment supplier or system integrator.

3.1 Product Inspection

- Upon receipt of this product, please verify that the product received matches the product that was ordered and that there is no obvious physical damage to the unit. If the wrong product was received or the product is damaged in any way, please contact the supplier from which the product was purchased.

3.2 Site Selection

- The installation site for the module should be chosen with several considerations in mind:
 - All units require adequate protection from the elements.
 - Adequate clearance should be allowed for easy access to terminals and adjustments. This will facilitate inspection and maintenance.
 - Sufficient circulation of clean, dry air should be provided. Ambient temperatures should not exceed +50°C (+122°F) nor be less than 0°C (+32°F) and non-condensing. Ambient air should not be contaminated with harmful chemical vapors or excessive dust, dirt, or moisture.
 - The unit will require a minimum clearance of six (6) inches above and below it to allow for proper airflow for cooling. Avoid mounting the unit with its air intake near heat sources.

3.3 Mounting

- Once the installation site has been selected as outlined above, and the mounting holes drilled and mounting studs or anchors installed, the resistive brake module is ready to be hung in position. Be sure all mounting hardware is tightened securely.
- Refer to Section 0 of this manual to determine the correct mounting dimensions and provisions for the unit.

3.4 Wiring and Customer Connections

3.4.1 Power Wiring



Only qualified electricians should perform and maintain the interconnection wiring of this product. All wiring should be done in accordance with local codes.

- Wire size should be selected in accordance with local codes, according to the current rating of the brakin. Use copper conductors rated 75°C. In general, the wire type should be selected by the nominal system AC voltage and the current rating of the module.

Table 0-1: Power Wiring Specifications

TERMINAL	CONNECTION	TORQUE
DC+, DC-, RES+, RES-	M8 stud	192 lb-in 22 Nm

3.4.1.1 DC Bus Connection

- As a general rule, 30 feet (10m) is the maximum total bus-work or cable that the dynamic braking module should be mounted from the drive. This means that the actual installation distance should be 15 feet (5m), as the cable must go out and back. If you must connect the choppers farther away, see the information below.
- The braking module must be connected directly to the DC bus filter capacitors of the drive.
- Refer to the drive manufacturer's manual or technical documents to locate the proper DC bus terminals. Your drive will have different terminal markings depending on manufacturer and drive series.
- Ensure that the polarity of the connection is correct. Incorrect polarity will effectively short the DC bus of the drive, and can cause severe damage to the drive, load resistor, and the DB unit.
- If the DB unit is connected to the terminals meant for the DC link choke, switching resonances caused by the DC link choke may destroy the DB unit.

3.4.1.2 Resistor Connection

- The polarity of the resistor connections is not critical; however, it is critical that the resistor be connected to the proper terminals. Improper hookup can lead to the resistor being connected directly across the DC bus, which will cause severe overheating and drive stress.

3.4.1.3 Grounding Requirements

- All units come equipped with either a ground terminal or ground stud that is connected to the module chassis. Ground the chassis in accordance with local codes. Typically, the wire gauge will be the same as is used to ground the attached drive.

3.4.2 I/O Wiring

Table 0-2: I/O Terminal Block Specifications: R7 Control Board

TERMINAL	FUNCTION	ELECTRICAL SPECIFICATIONS	MIN WIRE	MAX WIRE	TORQUE
TB4-1&2	Status Contacts	120Vac – 3 Amps	18 AWG	12 AWG	4.5 lb-in
TB8-1&2	Enable Reset	Dry Contact (24V, 100mA)			
TB6-1&2	Control Signal I/O	Analog	1mm ²	2.5mm ²	0.5 Nm

Figure 0-1: Customer Connections and Indicator Locations

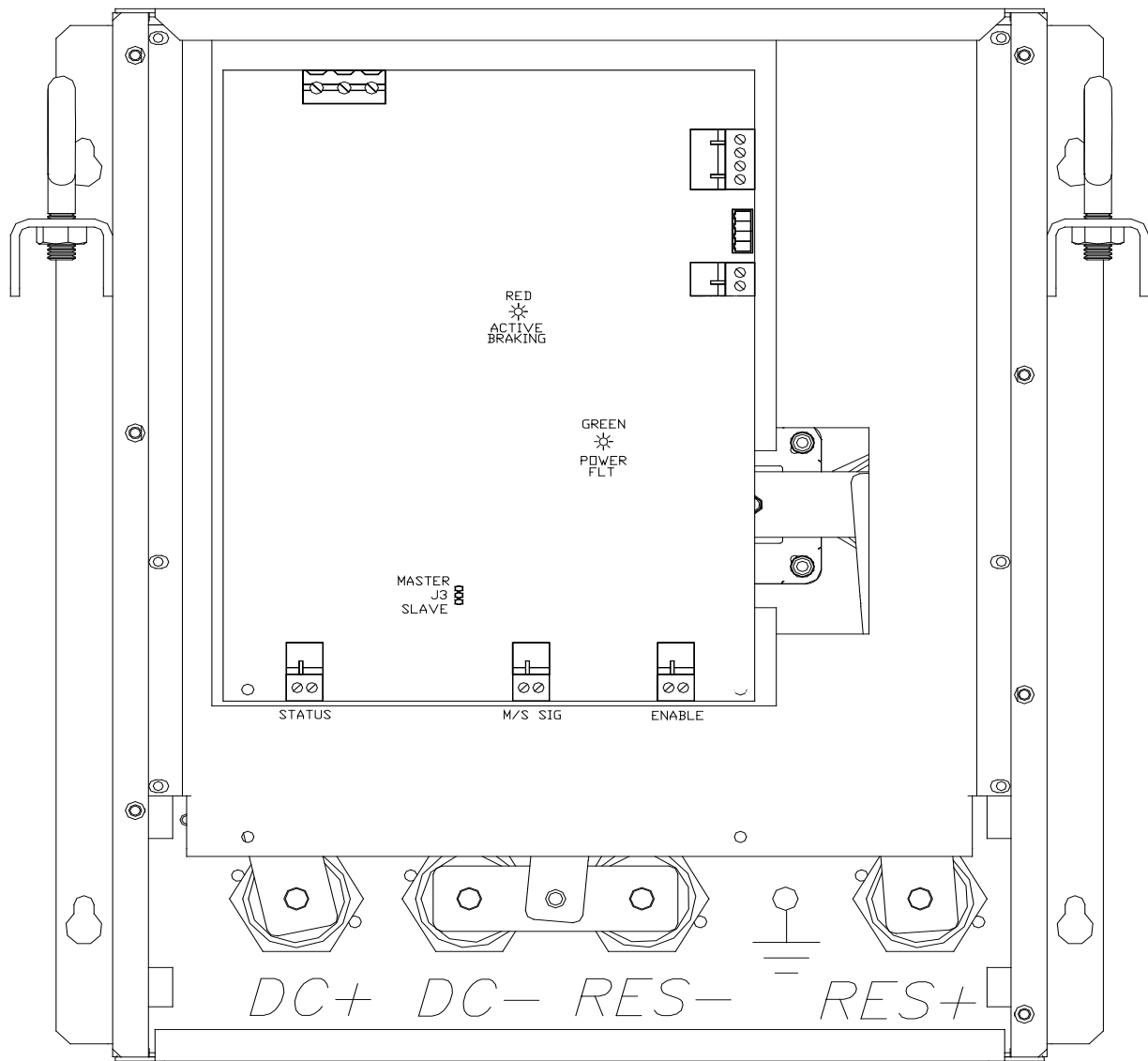

3.5 Typical Configurations

Figure 0-2: Master Stand-Alone Hookup

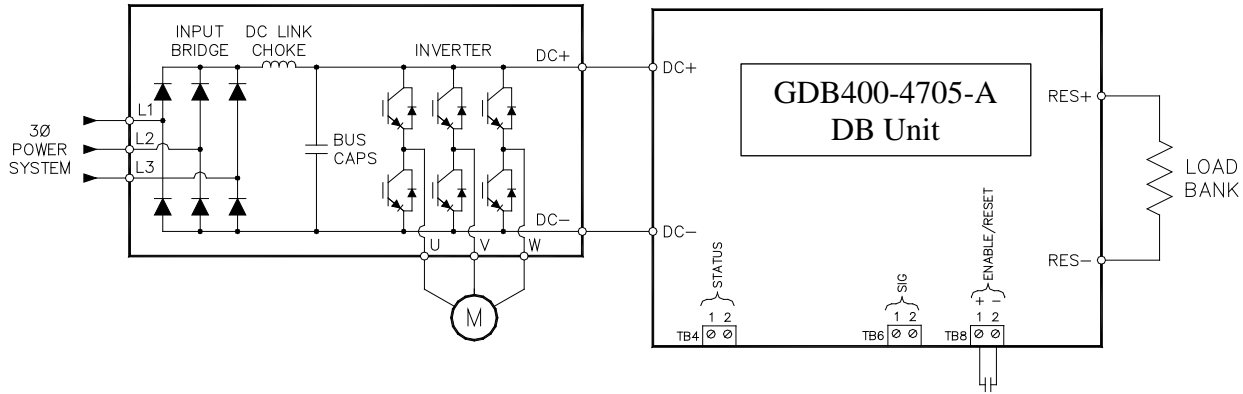

Figure 0-3: Master with Two Slave Modules Hookup

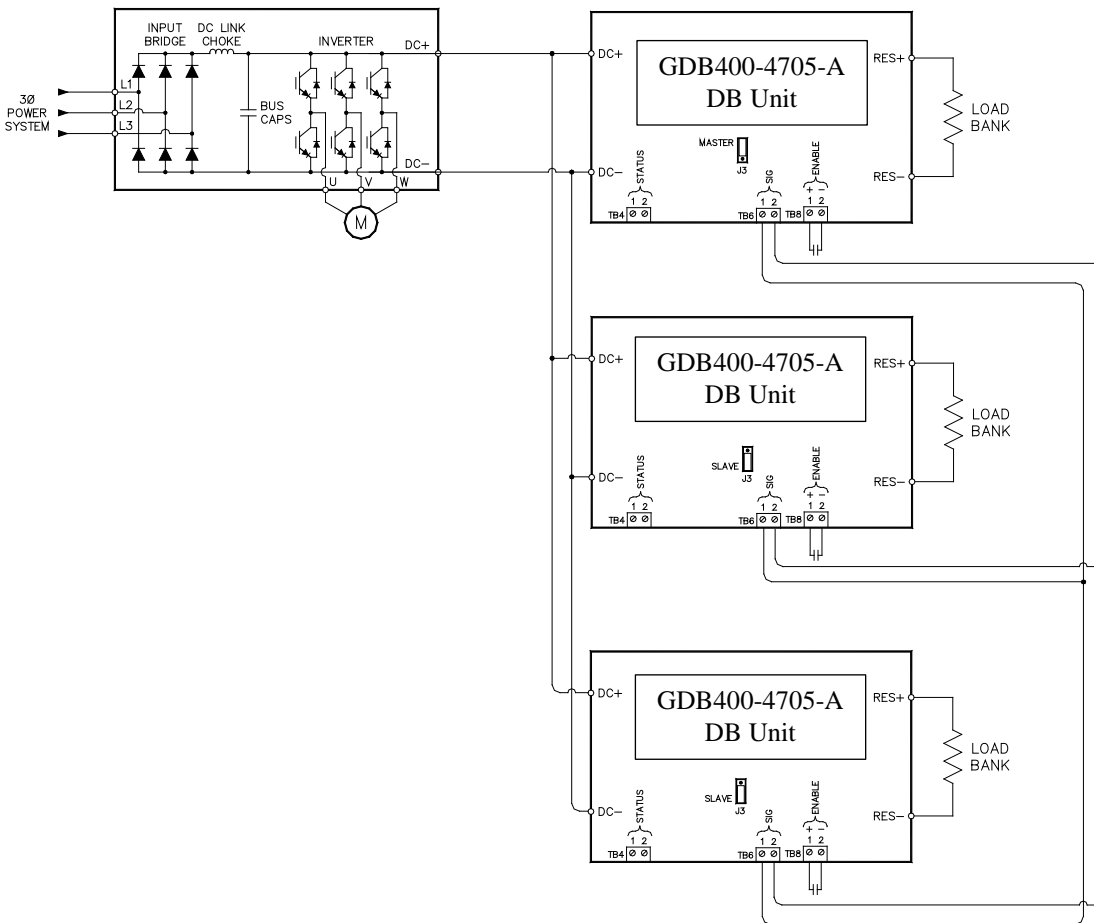
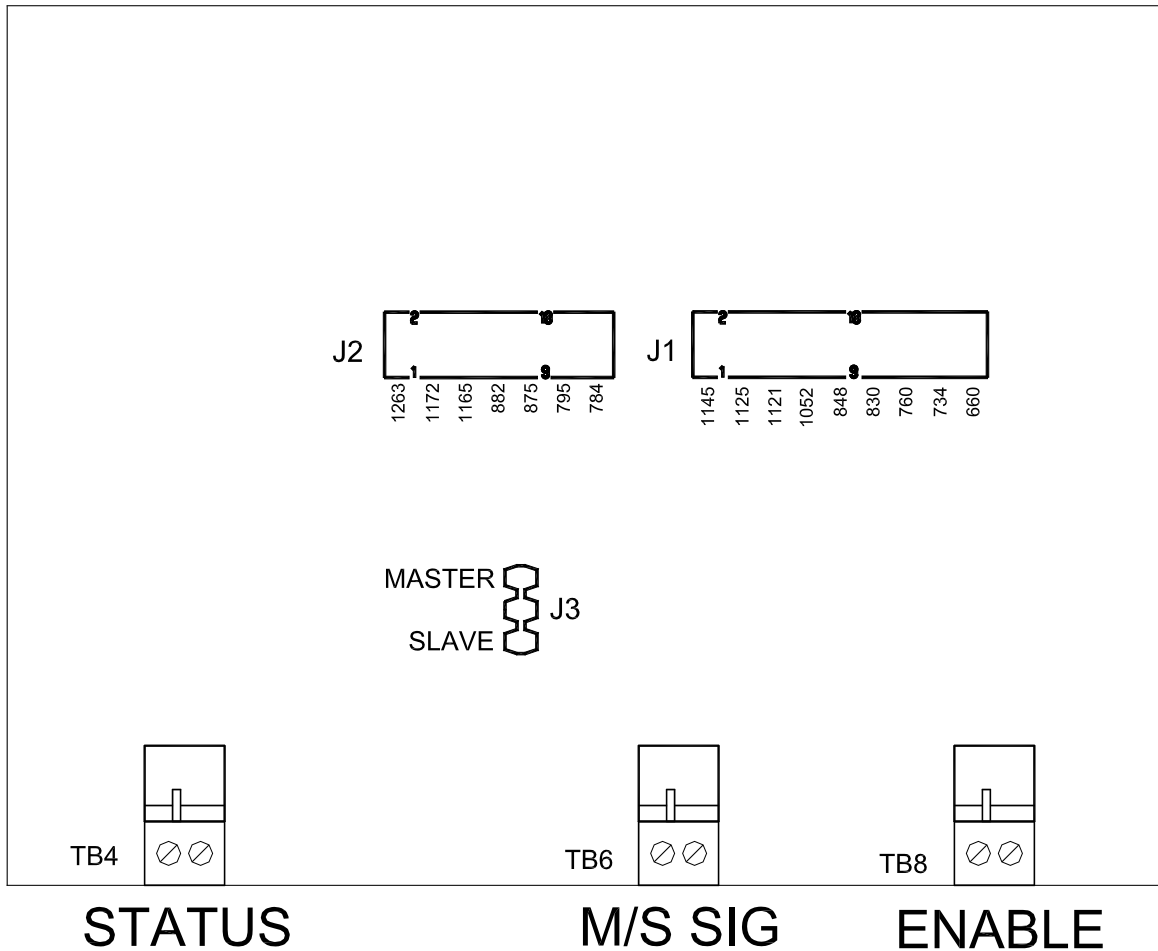

Figure 0-4: I/O Hookup 3452P1 Board



- Jumpers J1 and J2 control cut-in and overvoltage trip. Improper selection of J1 and J2 may result in damage to the drive.
- Consult table 4-2 of this manual, and the documentation for the drive before moving jumpers J1 and J2.
- Jumpers J1 and J2 must be correctly set BEFORE DC link voltage is applied to the drive and connected DB unit.
- See table 6-2 for recommended J1 and J2 selections that are compatible with the drives shown.

4. Operation

4.1 Functional Description

- The GDB400-4705-A module controls the bus voltage of a variable frequency drive by transferring energy to a resistor.
- When the drive’s DC bus voltage exceeds a fixed set point, the dynamic braking module’s control electronics turns on an IGBT connecting a resistive load across the DC bus. When the DC bus drops below another threshold, the IGBT turns off. The set points are listed in Section 6.

4.2 Features

- The GDB400-4705-A includes semiconductor fuses which limit the energy in the case of a control fault.

4.2.1 Indicators

4.2.1.1 Control Power / Fault Blink Codes

- This green indicator illuminates when control power is applied to the unit. A solid green light indicates that no faults are present and the control circuit is functioning. A flashing green light indicates a fault, with the pattern of flashing lights indicating the type of fault (see Table 4-1 below). All faults latch until a reset signal is applied. See Section 4.2.2.1.8 for more information about the reset input. The master/slave mismatch fault will not reset until power-down.

Table 4-1: Fault Conditions Table

NUMBER OF FLASHES	FAULT	INSTRUCTIONS
1	Logic Voltage	Consult Troubleshooting in Section 5
2	Overtemp	Wait for unit to cool
3	Over-Voltage	Contact Avid
4	Overcurrent	Reset
5	Master / Slave Mismatch	Reconfigure system with only one Master

4.2.1.2 Active Braking LED “LD3”

- This red indicator illuminates when the chopper IGBT is on. When the drive is idle, this red light should not be on. During braking, this red light will be on or flashing, depending on the amount of braking energy.

4.2.2 Terminal Strip I/O

4.2.2.1 Status Output – TB4-1&2

- This normally open contact indicates the status of the individual modules. When this contact is closed, the control and power section of the module have no faults. The Status contacts must be closed for the module to switch the attached braking resistor.
- For multiple chopper systems configured as Master/Slave, this contact must be closed for the chopper selected as master to control the attached choppers selected as slaves.
- If the power stage is not ready to operate, the control stage can continue to operate attached slaves.

4.2.2.2 Enable / Reset Input – TB8-1&2

- These terminals must be connected for the module to regulate the DC Bus.
- Modules are enabled by closing a dry contact between the terminals. Once they are closed, the Status contacts should close, indicating that the module is ready for operation.
- To reset the module, momentarily open these terminals >0.5 seconds.

4.2.2.3 Master/Slave Select Jumper – J3

- This jumper determines the operation mode of the module. When J3 is in the MASTER position, the unit will operate in Master or Stand-Alone mode.
- For Slave operation, move jumper J3 to the SLAVE position.

4.2.2.4 Master / Slave Signal – TB6-1&2

- These terminals are used for the Master/Slave communication port used in multiple unit configurations. The signals of all modules are connected in a “daisy chain” (+ to +, - to -).
- The port is bidirectional, serving as an output for modules operating in the Master Mode, inputs for modules operating in the Slave Mode.
- The signal is a complex waveform that is not reproducible as an analog input or output.
- See Section 4.2.3 for further information on Master/Slave configurations.



Do not attempt to use these signals for any purpose other than interconnecting Avid GDB400-4705-A units! Damage may occur to the GDB400-4705-A as well as to the connected equipment!

4.2.3 Master / Slave Control

- In order to achieve current ratings higher than possible with a single module, several braking modules can be connected in parallel. This method requires that one module be in control of all other modules. This module is considered the Master and the others are slaved to it.
- **Each module must have its own dedicated load bank!**
- If the output of modules is wired in parallel, severe current imbalances will damage the units.
- Parallel modules do not have to have the same current rating; however, each module must have a load resistor appropriate for the individual module's current rating.
- Up to 9 additional modules can be driven from a Master module if all Slave modules are within close proximity of the Master module.



WARNING!

AT NO TIME should more than one Master be selected simultaneously. If multiple masters are selected, all but one will detect the condition and cease operation. This fault can only be cleared by powering down the system and powering back up with only one master module. Ensure that the logic control will select only one Master at any given time.

4.2.3.1 Wiring for Master / Slave Operation

- The control signal for parallel systems should be wired in a “daisy chain” configuration, with all (+) signals connected and (-) signals connected. Use twisted/shielded pair cable for interconnection. See Section 4.2.2.4 for additional information.
- **Do not exceed 15 feet of total cable length to connect the Master pulse to the farthest Slave module.**
- Excessive distance can lead to unacceptable noise in the signal lines, and can cause false triggering, poor operation, or catastrophic system failure.

4.2.3.2 Master / Slave selection jumper

- Jumper J3 controls the mode selection of the individual modules. Master mode is selected by inserting jumper to the Master position.
- All modules have a status output. The Status contact indicates that the module's bus regulation circuitry is functioning and the modules power switching circuitry is ready.
- If a module is selected as Master, and the power section is not ready, that module will continue to control slave modules as long as it is enabled and the regulating circuit is functioning on the Master modules. The Master module with the power stage not ready will not switch its own power stage. This allows the braking system to operate at reduced capacity in the event of a Master module power stage failure.
- If a module is selected as Master and the bus regulation circuitry is not active or faulted, no bus regulation will occur.
- For modules selected as Slaves, both the Enable and Power Stage must be active for that module to switch and regulate the DC bus. The operation of other modules is not affected.

4.3 Startup

4.3.1 Pre-Power Checks

- Ensure that all connections are tight, DC bus polarity is correct, and that all field wiring is of the proper size for operational requirements. Check for exposed conductors that may lead to inadvertent contact. Verify the load bank is properly sized for the application. The ohms value and wattage rating of the load bank are important for proper and reliable system operation! ***Remember: do not operate the module with less than its minimum ohms value rating!*** Verify that J1, J2 and J3 “Master / Slave” jumpers are in their proper position for intended use.

4.3.2 Cut-In and Overvoltage Selections, J1 & J2

- This module has selectable voltage levels for Cut-In and Overvoltage for compatibility with multiple drives. These jumpers are factory set at the highest levels to avoid premature turn-on on higher voltage systems. Refer to Table 6-2 for compatible drives and jumper settings.

Table 4-2: J1 and J2 Positions

J1 POSITIONS	CUT-IN VOLTAGE (VDC)	J2 POSITIONS	OVER VOLTAGE TRIP (VDC)
1145	1145 VDC	1263	1263 VDC
1125	1125 VDC	1172	1172 VDC
1121	1121 VDC	1165	1165 VDC
1052	1052 VDC	882	882 VDC
848	848 VDC	875	875 VDC
830	830 VDC	795	795 VDC
760	760 VDC	784	784 VDC
734	734 VDC	-	-
660	660 VDC	-	-

4.3.3 Master/Slave, J3

- If the module is the only module used in the system, it should be set as Master. Place jumper J3 in the Master position for stand-alone systems or systems that have a static Master. In systems that have multiple units, refer to Section 4.2.3 for more information on setting up systems with multiple units.

4.3.4 Startup Procedure and Checks

- Apply AC power to the drive system and the Dynamic Braking Module. Do not start the motors on the system.
- On the dynamic braking module, verify the following:
 - Green **LED “LD1”** on PCB is **ON**.
 - If **ENABLE** input is shorted **STATUS** contacts should be closed.
 - Red **Active Braking LED “LD3”** indicator is **OFF!** **Immediately** turn off all power if the indicator is **ON** to avoid possible load bank overheating and/or other equipment damage!
 - Verify the drive system DC bus voltage, and make sure it is within tolerance for the drive system.
 - Verify the DC current flow through the load bank is zero amps. Even though the Red **Active Braking LED** is **OFF**, any significant current flow could indicate incorrect connections or damaged equipment. **Immediately turn off all power to avoid possible load bank overheating and/or other equipment damage!**
 - Note: Depending on the type of measuring equipment used, small currents could just be noise pickup and could be ignored.
 - Check status contacts to ensure they are all closed. This indicates that the module is ready for operation.
- If any of the above conditions are not as indicated, turn off all power and allow ample time for all system energy sources to discharge. **Verify that all voltages are zero and have discharged with a suitable meter!** Check all wiring connections and jumper configurations. Refer to the Troubleshooting Section of this manual for more information. For further assistance, contact Avid technical support.
- Once the pre-checks are complete, the drive system can be enabled. Once the drive system is operational, run the motors with light deceleration, and decrease the braking time until the red Active Braking LED lights.

4.4 Operational Adjustments

- No adjustments are necessary for this module. All regulation points are factory adjusted, and should not be changed in the field. If your module is not functioning properly, refer to the Troubleshooting Section of this manual, or contact Avid for assistance.

5. Maintenance and Troubleshooting

- Repairs or modifications to this equipment are to be performed by Avid approved personnel only. Any repair or modification to this equipment by personnel not approved by Avid will void any warranty remaining on this unit.

5.1 Periodic Testing

- At least every other month, visually inspect the internal board indicator LEDs to be sure they are operating correctly. With control power applied, the green **Control Power LED** should be illuminated. The red **Active Braking LED** will only be on or flashing if the module is switching energy from the DC Bus. There are no operational tests to be performed.

5.2 Maintenance Items

- Monthly, check the module for buildup of dust, debris, or moisture. Dangerous voltages exist within the module and the buildup of dust, debris, and moisture can contribute to unwanted arcing and equipment damage. Take whatever corrective or maintenance actions are necessary to keep the module clean and moisture free.
- Monthly, check the cooling fan and heatsink for any buildup of debris. If they require cleaning **power down the drive system** and blow the debris out with clean dry air as necessary to maintain proper cooling performance. **Note:** After blowing out the fan and/or heatsink, blow off any dust or debris that may have gotten on any of the circuit boards.

5.3 Troubleshooting



Lethal voltages exist in these systems! Before attempting checks or repair, follow all precautions to ensure safe working conditions, including lockout / tagout procedures, and verifying safe working voltages with proper meters. Do not rely on the DC Bus indicator to ensure a safe condition.



Only qualified personnel familiar with variable frequency AC drives and associated machinery should plan or implement the installation, start-up, and subsequent maintenance of the system. Failure to comply may result in personal injury, death, and / or equipment damage!

Contact Avid any time the equipment appears to be having problems.

5.3.1 Green LED on PCB not illuminated

- Check Voltage input on customer terminal DC+ & DC-. Unit should be operational from 300Vdc – 1200Vdc.
- If voltage is within range at power terminals check voltage going in to TB1 1 & 3 on PCB 3452P1x.
- If voltage is within range at PCB, remove all power and check fuses F1 & F2. If fuse is open or LED will not light unit should be returned to Avid for inspection/repair.

5.3.2 Fan doesn't run

- The fan should be running whenever power is applied.
- If the fan does not run when power is applied, check the following:
 - Verify green power LED on PCB is on with power applied.
 - Check fan for blockage. Clean if necessary.
 - Check fan voltage and ensure it is within tolerance and correct polarity.
 - Replace fan.
 - If fan still doesn't operate, contact Avid for return for repair.

5.3.3 Status contacts won't close

- If the status contacts listed in Section 4.2.2.1 above will not close, this indicates one of the following conditions:
 - Open ENABLE input
 - Loss of Control Power
 - Failure in control circuit
 - Over-temperature in module
 - Over-Voltage
 - IOC fault

5.3.4 Module over-temp, or module seems too hot

- It is normal for this module to produce heat. Temperatures of 150°F are not uncommon. If the modules fan is running, and the module is operating properly, it is within normal tolerances.
- If the fan is running, check to make sure the airflow through and around the module is unobstructed.
- If the ambient temperature is high in the cabinet or installation area, the module may overheat. Make sure the environment is within the operating temperature requirements listed in the General Specifications.

5.3.5 Drive trips on overvoltage



Make sure the DC+ and DC- connections are made directly to the drive system bus. They should not be connected to terminals dedicated to an internal transistor circuit on the inverter.

- If the drive trips on overvoltage, confirm that the green Control Power light is on (5.3.1). Ensure the Enable input is shorted and the status contacts are closed (5.3.3). Watch the red Active Braking light on the 3452P1 control board during a braking cycle. If it never illuminates, ensure that the module is either configured as a master, or correctly wired to a properly configured master (4.2.3). There must be only one master in the system. Check the DC Bus voltage and make sure the bus voltage at the braking module exceeds the trip point of the module, i.e. 750VDC for a 460VAC nominal system.
- If the red Active Braking light comes on, check the wiring to the load bank, and check the current to the load bank with a clamp on current meter. If the red Active Braking light comes on, and current is flowing to the load bank, check to make sure that the module is sized properly for the system. If the resistance of the load bank is too large, not enough current will flow to allow for the braking energy to be dissipated. Check the system design to make sure the braking requirements are matched with the braking module capacity.

5.3.6 Master/Slave systems

- Master/Slave systems must be properly configured and operating to share the load.
- Check your system layout and make sure there is only one selected and operating Master and that all the Slaves are properly wired to that Master.
- Make sure that all the modules have the control power lights on with no faults.
- When the system is braking, watch the Active Braking lights on all modules. They should all go on and off at the same time. If they do not, there may be a wiring or module configuration issue.
- If the lights all go on at the same time, check the current going to each load bank as above and correct problems found with the wiring.

5.3.7 Red Active Braking led flickers

- During motor deceleration, the red braking LED on PCB may flicker if the braking cycle energy is low. This is normal.
- If the red braking light flickers when the inverter is idle, this may indicate high voltage, excessive noise, or harmonics on the main system rectifier input AC voltage. Check the incoming AC line for these problems. Consult the project engineer for the appropriate corrective action.

5.3.8 Red Braking light stays on all the time

- System voltage is too high or high harmonic content is present. Check main system rectifier input AC voltage. Refer to the DC Bus cut-in level found in 4.3.2. The undistorted main system rectifier AC input voltage should always be less than cut-in voltage / 1.414
- Note that if the measured DC Bus (with the drive disabled) is greater than $1.414 \times \text{RMS line voltage}$, then harmonic distortion may exist. Consult the project engineer for the appropriate corrective action.
- Incorrect Cut-In voltage selection on J1.
- Set point too low. The DC bus set point pot on the main control board may have been tampered with. If this is a possibility, then the module needs to be sent in for recalibration.
- Wrong braking module installed. Check the module chassis sticker for the part number. Refer to Section 2.2 of this manual and verify the sticker information represents the correct part number for your application and voltage levels. Remove and replace as required.
- Main control board has gone bad and the module needs to be sent in for repair.

5.3.9 Master Unit appears to function properly, but Slave Units do not seem to follow the Master

- Slave(s) may have missing or insufficient control voltage. Refer to Section 5.3.1 and correct as required.
- Check the signal wiring between modules. The terminals should be daisy chained as described in Section 4.2.3.1.
- Make sure that only one module is selected as Master on a network. More than one master can cause improper triggering and system damage.

5.3.10 Attached Drive Will Not Precharge

- Verify the polarity of the connection to the DC filter capacitors of the drive. If this connection is reversed, the commutation diode effectively shorts the DC bus and will not allow the drive to go through precharge.

5.4 Technical Help – before you call

- If technical help is required, please have the following information available when contacting Avid:
 - Serial number of unit
 - Name of original equipment supplier
 - Brief description of the application
 - Drive and motor hp or kW
 - The line to line voltage on all 3 phases
 - The DC Bus voltage
 - KVA rating of power source
 - Source configuration Wye/Delta and grounding

6. Engineering Data

6.1 Ratings Chart

Table 6-1: GDB400-4705-A Ratings

MODEL NUMBER	BRAKING CURRENT (PEAK)	BRAKING CURRENT (RMS)	DUTY CYCLE	MINIMUM RESISTANCE
GDB400-4705-A	400 A	100 A	25%	2.93 Ω

Table 6-2: GDB400 to GD3000 or MV3000 Cross Reference

ORIGINAL MODEL NUMBER	SYSTEM VOLTAGE (VAC)	DC LINK CUT-IN VOLTAGE (VDC) ⁽¹⁾	DRIVE OV TRIP VOLTAGE (VDC) ⁽²⁾	COMPATIBLE PART NUMBER	MINIMUM RESISTANCE (Ω)
GDB400-4601	690 V	1125 V	1165 V	GD3000E DELTA SYSTEMS	2.91 Ω
	525 V	830 V	875 V		2.18 Ω
GDB400-4602	480 V	760 V	795 V	GD2/3000E BDM AND GD DELTA SYSTEMS	1.98 Ω
	415 V	660 V	795 V		1.98 Ω
GDB400-4603	525 V	848 V	882 V	MV3000e MICROCUBICLE AND MV DELTA SYSTEMS	2.20 Ω
	440 V	734 V	784 V		1.96 Ω
GDB400-4604	690 V	1121 V	1172 V	MV3000e MICROCUBICLE AND MV DELTA SYSTEMS	2.93 Ω
	600 V	1052 V	1172 V		2.93 Ω
GDB400-3705	690 V	1145 V	1263 V	MARINE SPECIAL MV3000 DRIVES	2.93 Ω

⁽¹⁾ Jumper J1 selects the Cut-In voltage, which is the voltage which the GDB400 will activate

⁽²⁾ Jumper J2 controls the DB Overvoltage selection.

Table 6-2: Watt Loss

UNIT PEAK CURRENT	CONTROL POWER WATT LOSS	HEATSINK WATT LOSS
400 A	55 W	750 W

6.2 DC Bus Link Length Limits

- The distance that the chopper is mounted from the main DC bus filter capacitors within the drive is limited by the amount of inductance in the connection. During switching, the inductance in the DC bus between the chopper and capacitors stores energy that must be absorbed by the snubbing circuit in the chopper.
- In general, this distance should be kept to a maximum of 30 feet total (10m), or 15 feet (5m) for the DC+ link and 15 feet (5m) for the DC- link.
- The distance between the DC bus filter capacitors and the braking chopper can be increased by using lowering the inductance of the bus work or cables. Typically, this means using bus work or cable with a higher cross sectional area. The inductance of the bus work can be calculated from the length and inductance/foot published by the cable manufacturer. There are also standard tables to help this calculation.
- If there is an extreme distance with inductance that cannot be removed from the DC bus, additional bulk capacitance can be added to decouple the DC bus inductance from the system, or the chopper can be repositioned to minimize the distance from the DC bus filter capacitance.

Figure 6-1: DC Link

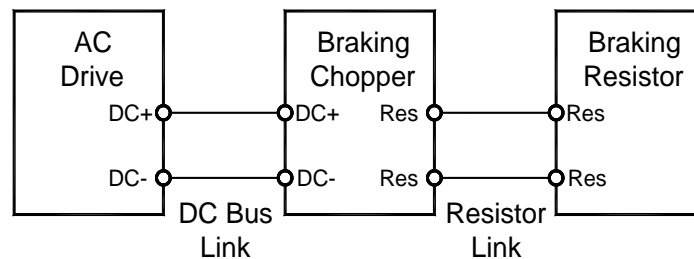

6.3 Resistor Link Length Limits

- The distance that the resistor is mounted from the chopper is not a concern for the chopper as the components used will not be affected by this inductance.
- Some ceramic or wirewound resistors can have significant inductance, grid or plate resistors do not. In very extreme cases, the inductance of the resistor and connecting cables may limit the rise time of the current to the resistor, but this will not have an impact on chopper operation.

6.4 Dimensions and Mechanical Drawings

Figure 6-2: GDB400-4705-A Chassis Dimensional Outline Drawing (all dimensions in inches)

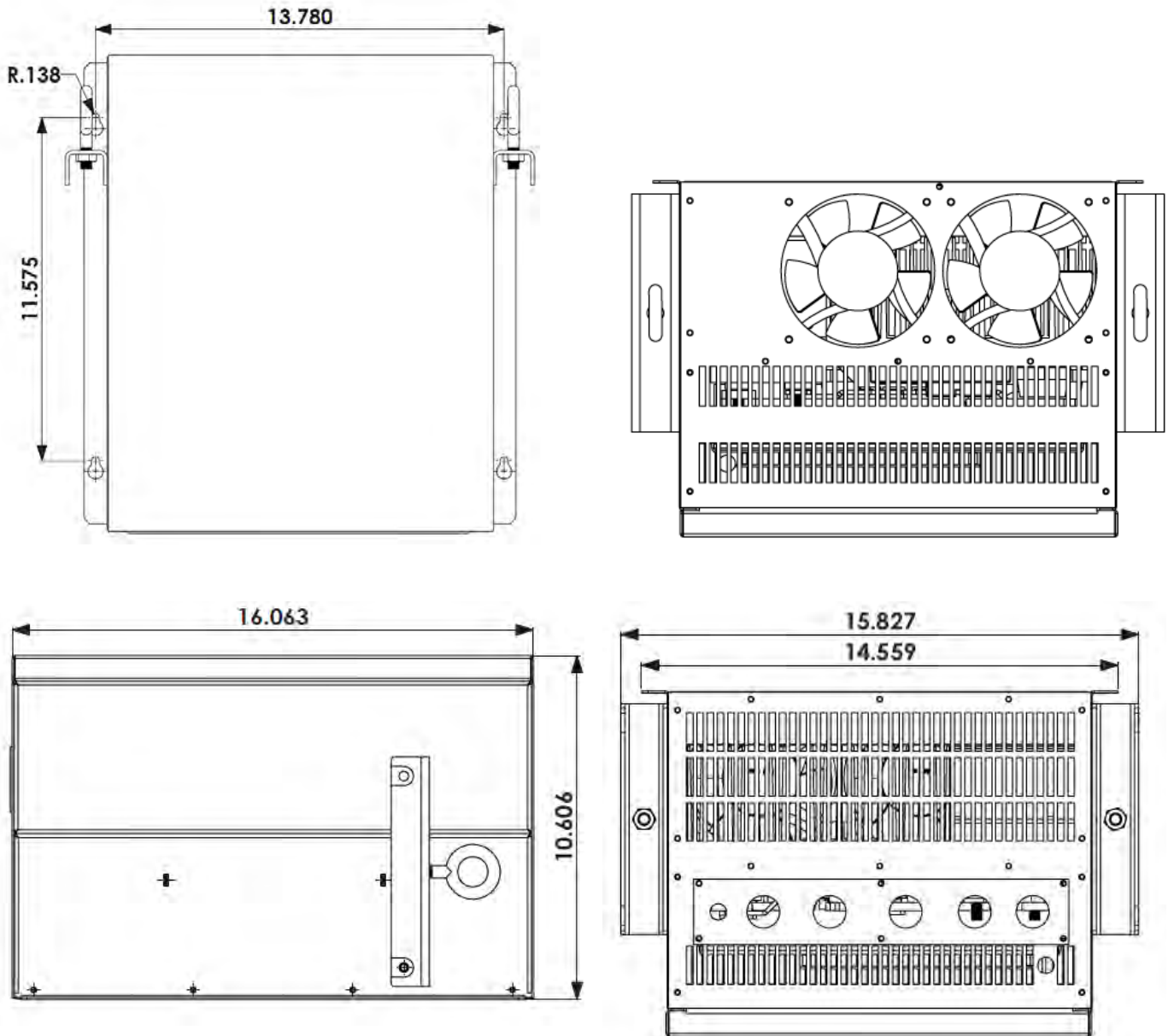

6.5 BLOCK DIAGRAMS

Figure 6-3: GDB400-4705-A Block Diagram

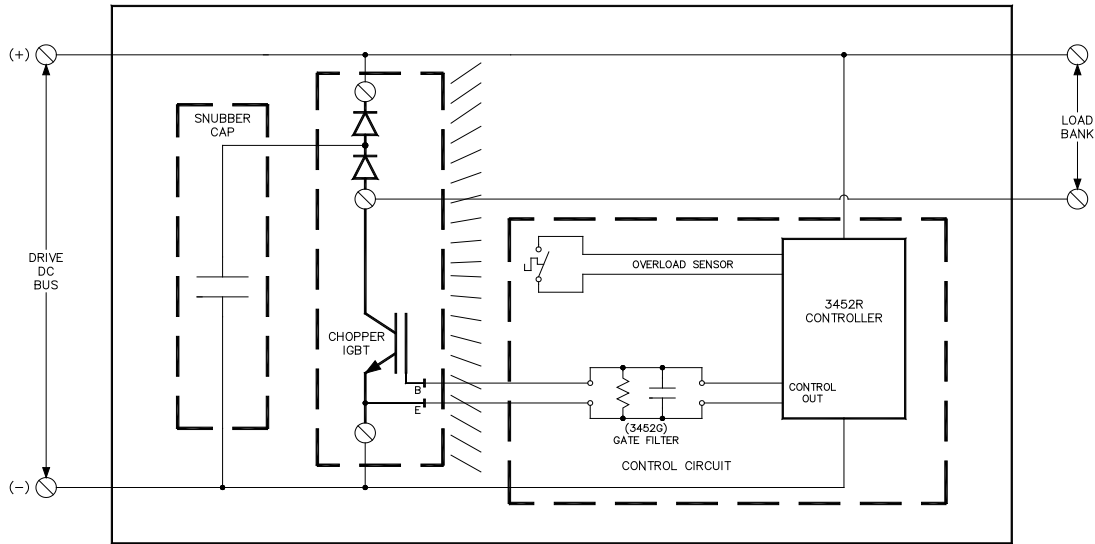

7. Document Revision History

Rev.	Date	Author	Changes
00	2/1/2018	Gary Pace	Document created
01	2/26/2018	Lori Savell	Corrections and Updates